

ME 1403 Engineering Practice & Graphics  
Spring 2018

# Lecture 2

Chapter 3

Instructor:

Syed Hasib Akhter Faruqui

[Email: shafnehal@gmail.com](mailto:shafnehal@gmail.com)

# Outline

- Tools / Methods
  - Labeling Dimensions
  - Convert Entities
  - Trimming/ Extending
  - Offsetting
  - Fillet / Chamfer
  - Pattern

# Labeling Dimensions

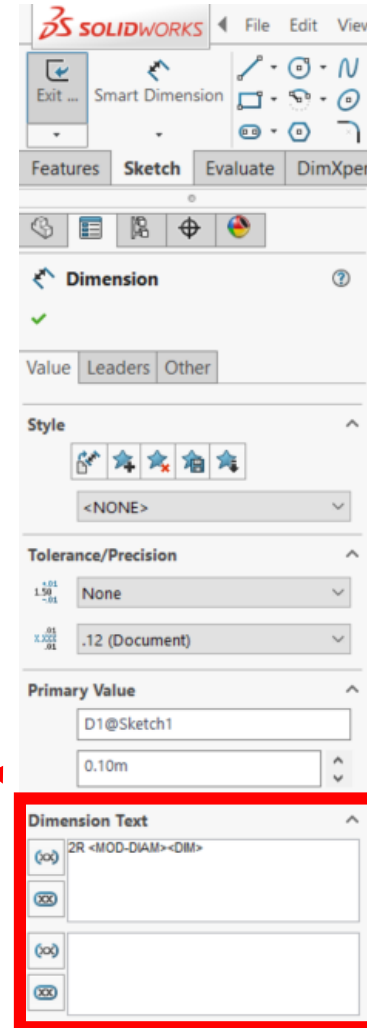
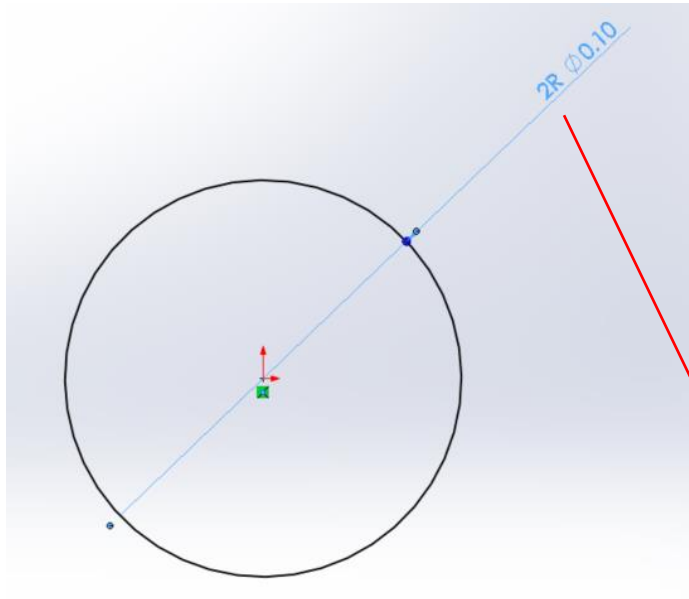

# Trimming Tool

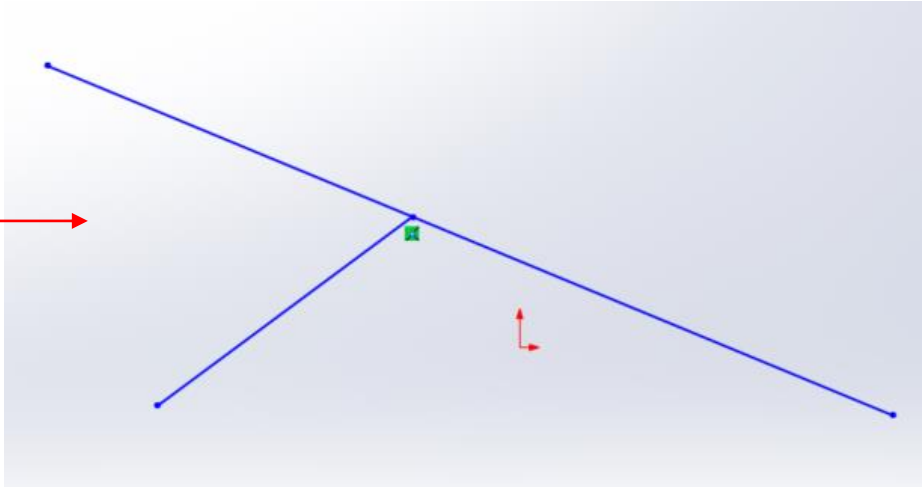
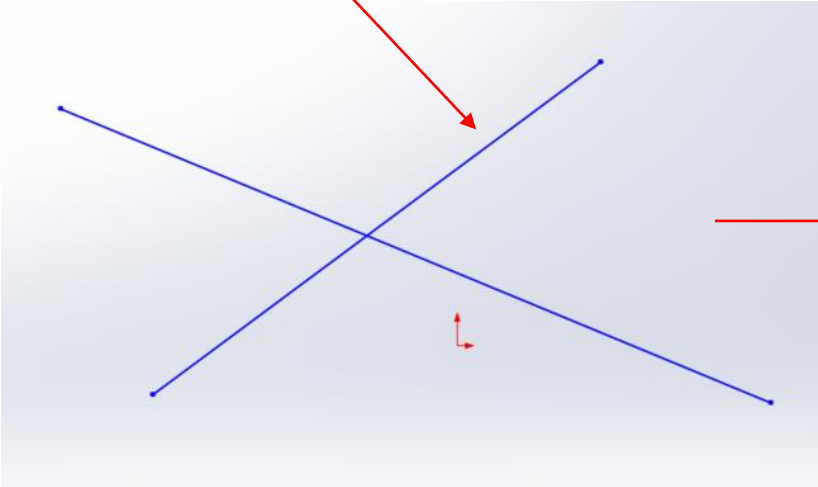
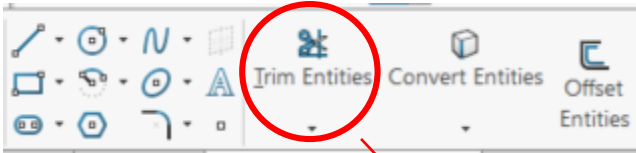

# Trimming Tool

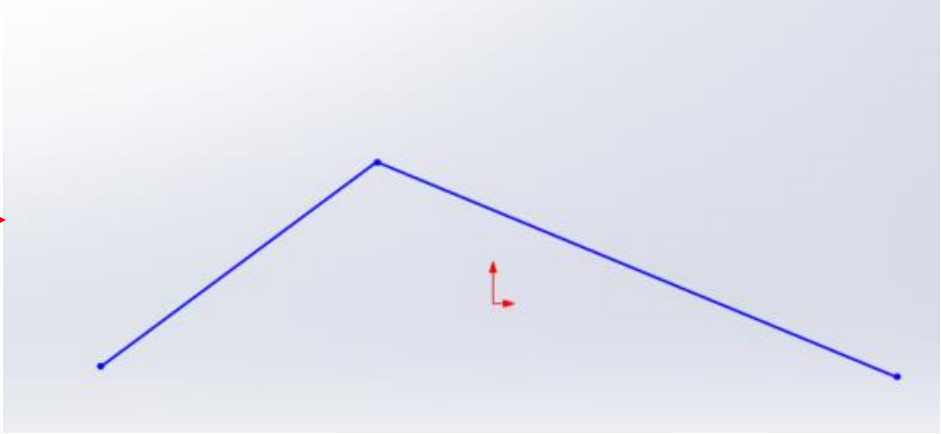
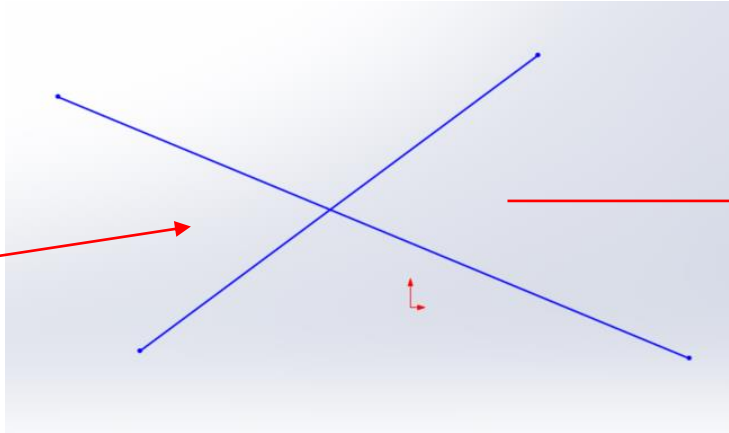
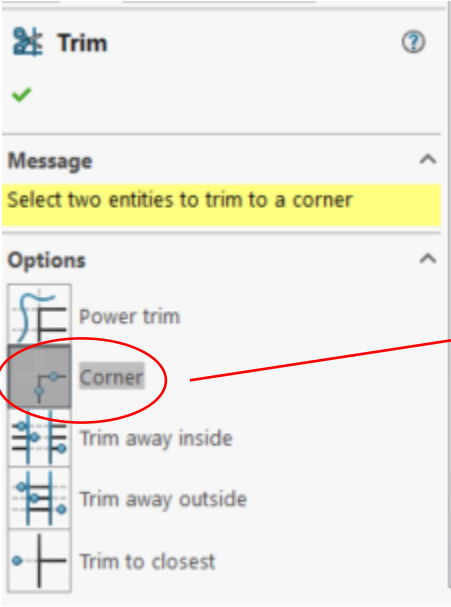
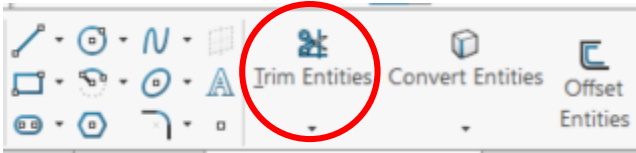

# Extending

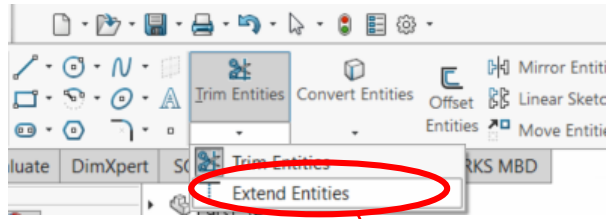

Select the line

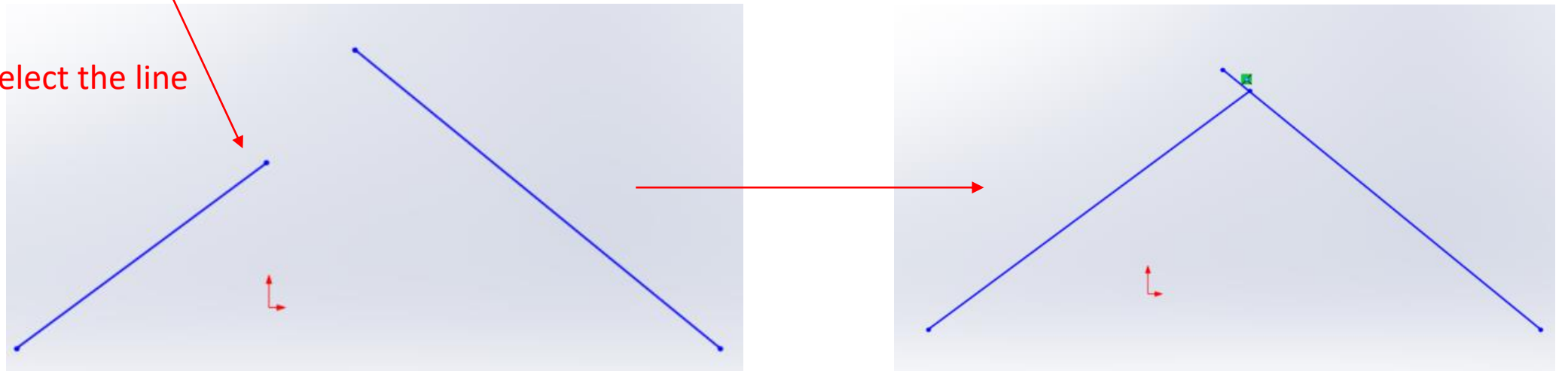

# Offsetting

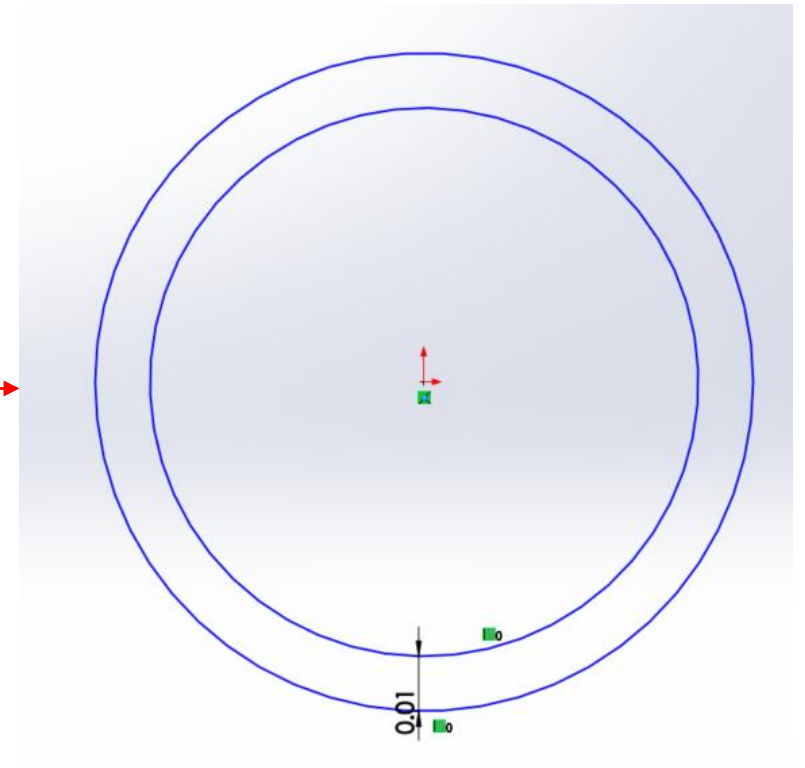
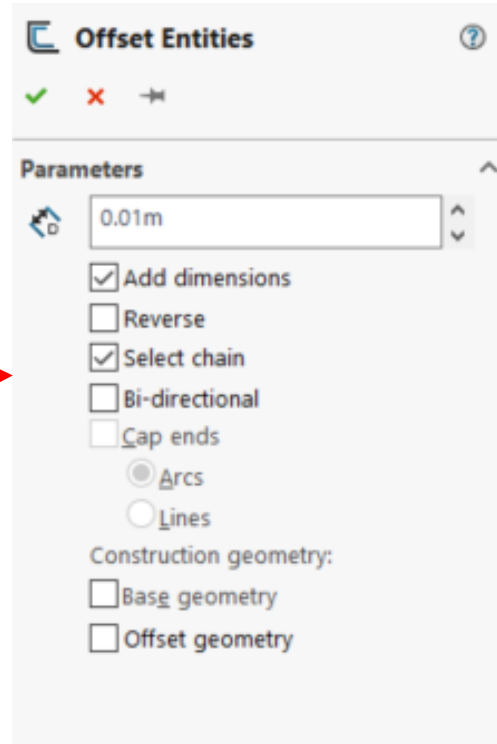
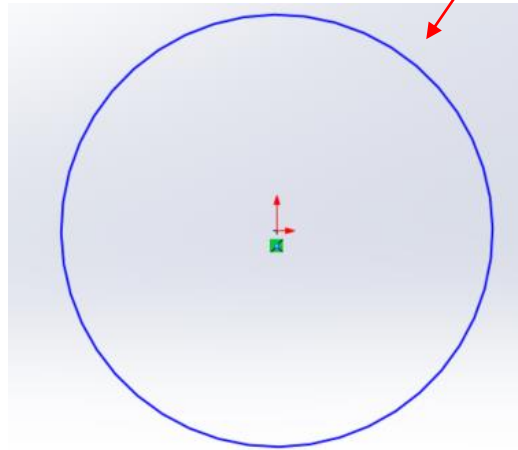
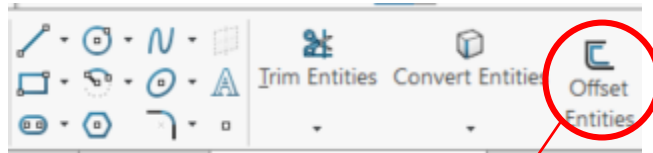

# Fillet

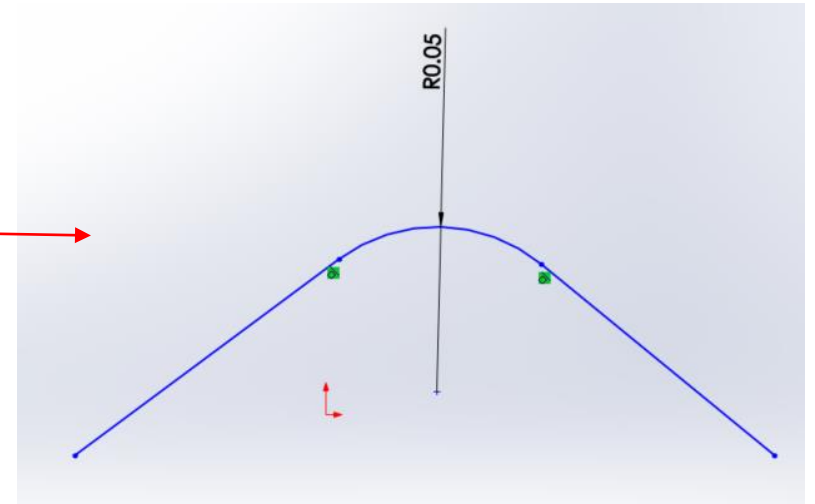
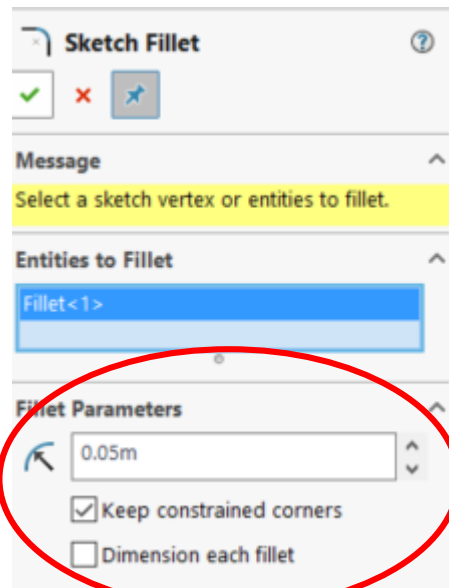
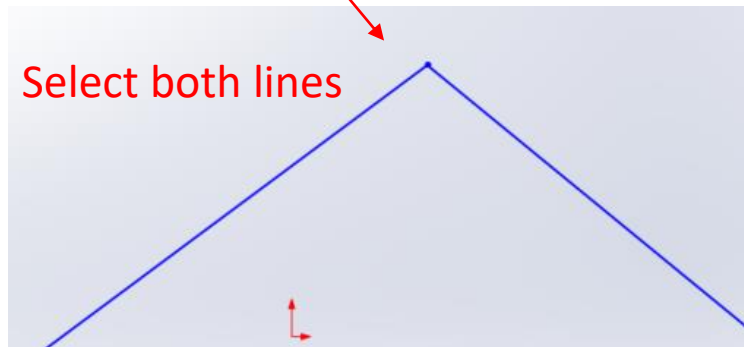
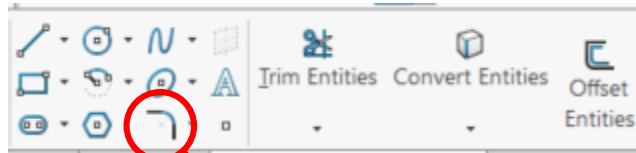

Enter Fillet Parameter



# Chamfer

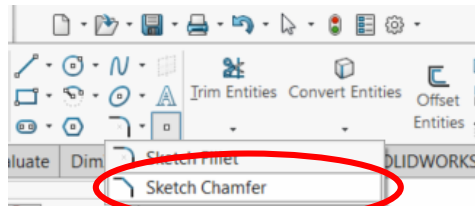

Select both lines

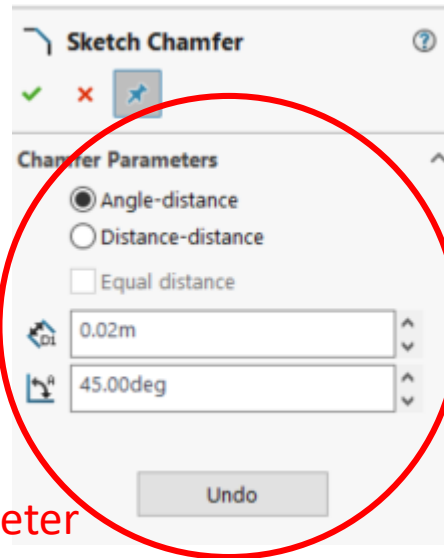
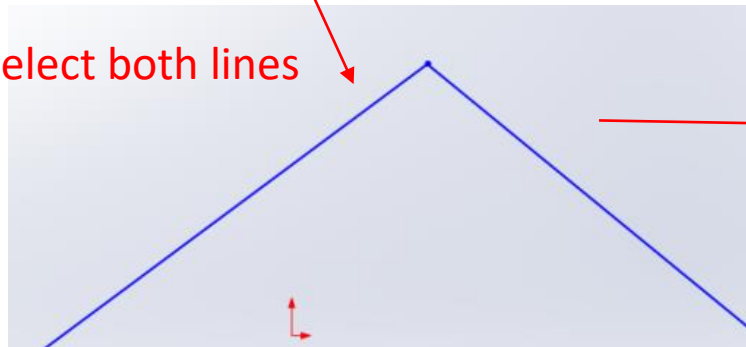

Enter Parameter

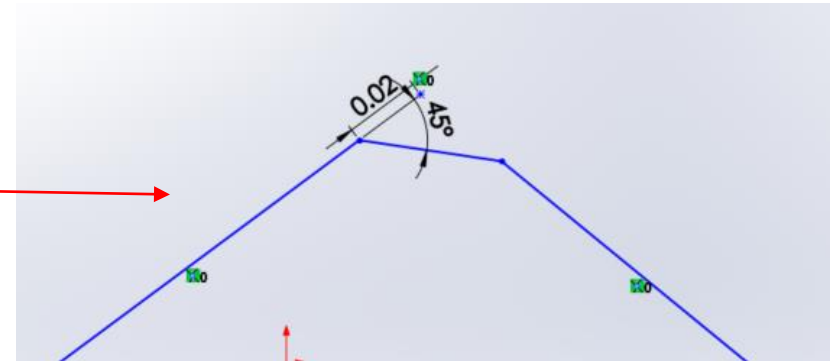

# Pattern (Linear)

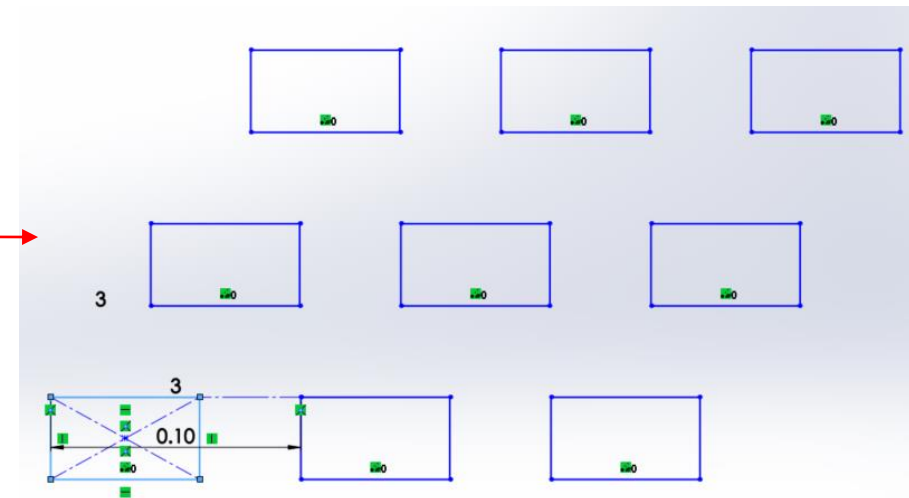
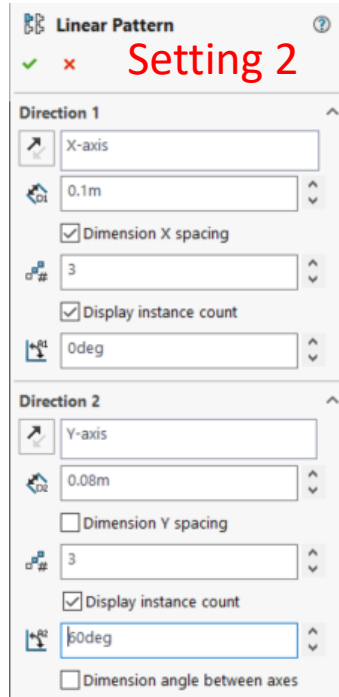
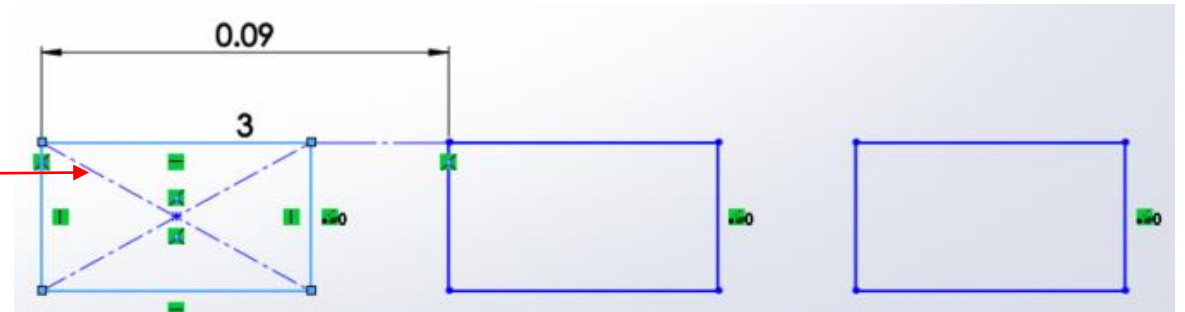
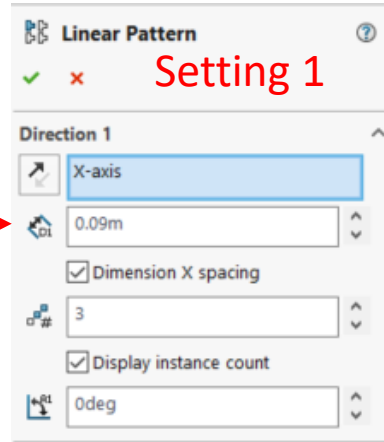
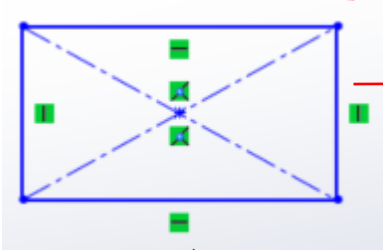
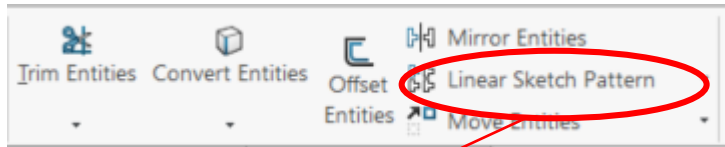

# Pattern (Circular)

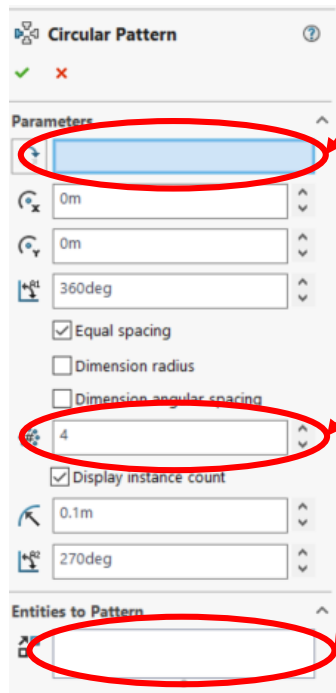
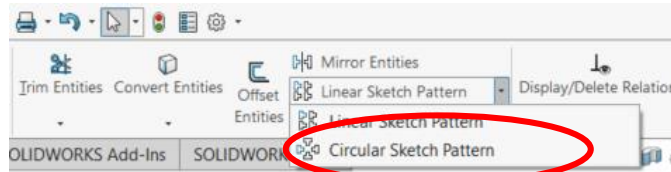

Select point around which you want the pattern

Select this center point

Number of Pattern

Select these Entities

Entities to pattern

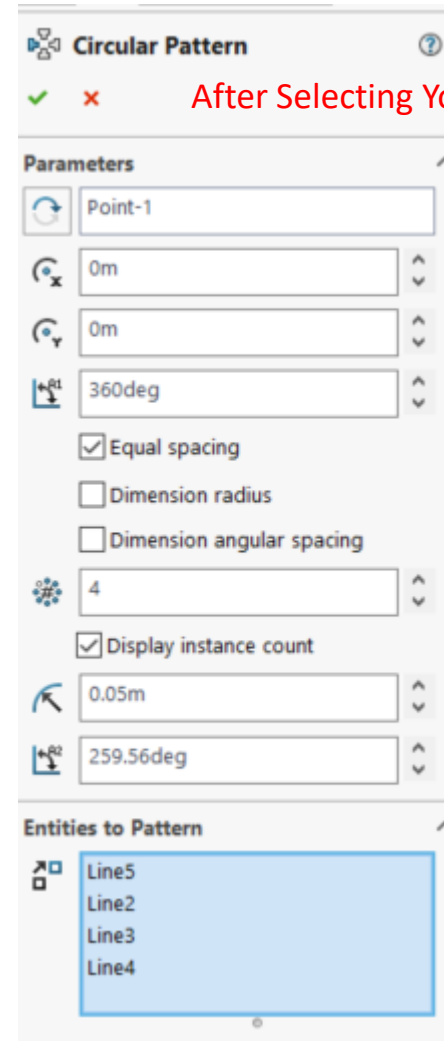

After Selecting Your parameters

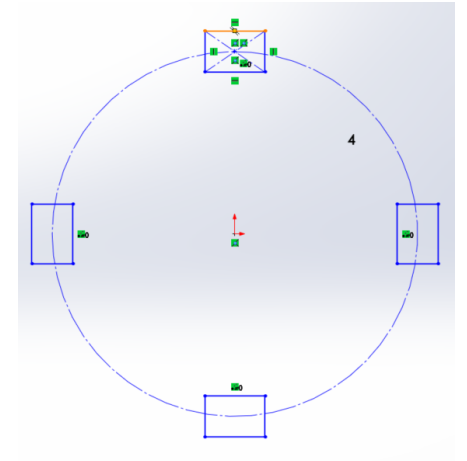

# Announcement!

## Quiz 1 (Next Class)

- Topics:
  - Chapter 2
  - Chapter 3
    - Fillet/Chamfer
    - Trimming/ Extending
    - Offsetting
- Time
  - 15 minutes

# Submission Rules

- Homework's are due **at the Monday 11.59 P.M.** of the following week (*More Discussion on next class*).
- Quiz's will be taken (*More Discussion on later classes*).
- Submit everything via **Blackboard**.
- Copying your assignments are **prohibited**. If you do so, you and the individual you copied from will receive a **grade zero**, plus both of you will be referred for actions as described in the university's policy for academic dishonesty. ([Read Section 203 of the Student Code of Conduct 2013-2013 UTSA Information Bulletin.](#))